

# LOKHEN SOLUTIONS

NEWS  
**#Origamy**  
The Foldable

Best safety for your documents

Hose Tube.  
Holders range.

**WHEEL CHOCK**

The widest range

Water tanks

all the comfort  
of water on board

**BRIKY**  
NEW PRODUCT



# ORIGAMY®

THE FOLDABLE!

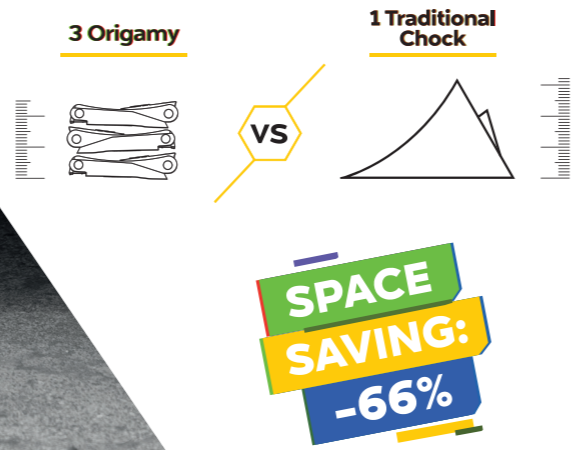

## ORIGAMY 53

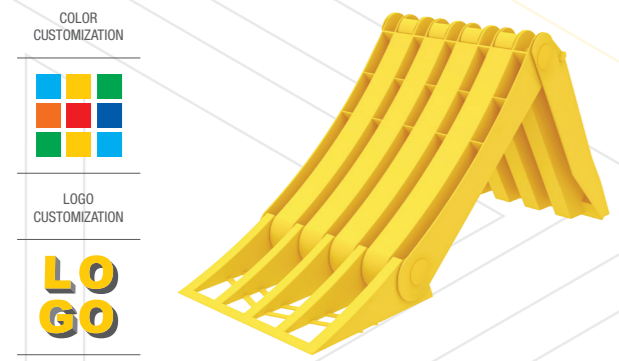

PATENTED

HOMOLOGATION

REGISTERED DESIGN

## ORIGAMY 36

NEW

PATENTED

HOMOLOGATION

REGISTERED DESIGN

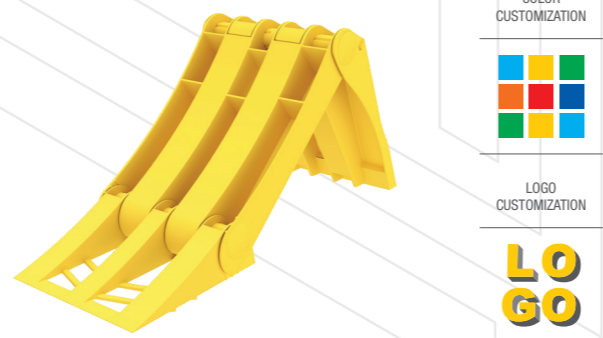

## BEAM SINGLE & DOUBLE

NEW

PATENT PENDING

COLOR CUSTOMIZATION



## ALOK SINGLE & DOUBLE

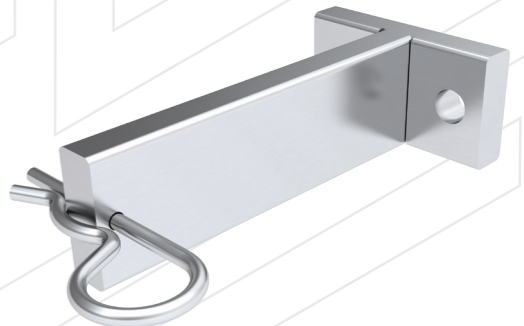

## BOX

COLOR CUSTOMIZATION

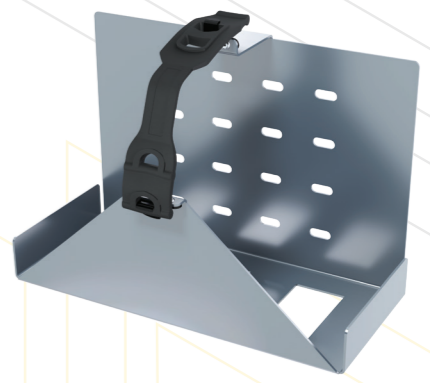
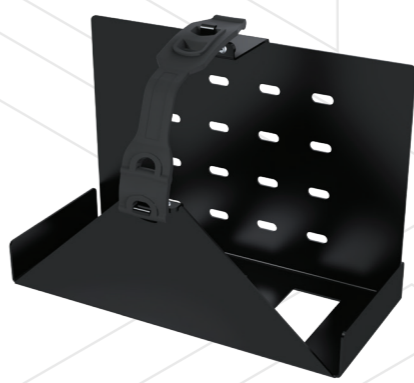

www.lokhen.com



www.lokhen.com

# #The Widest Range

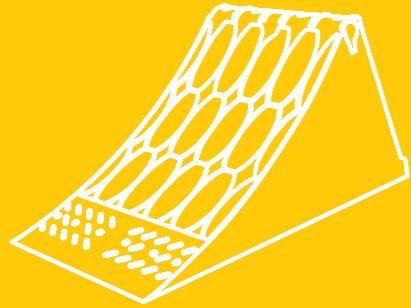

## WHEEL CHOCKS

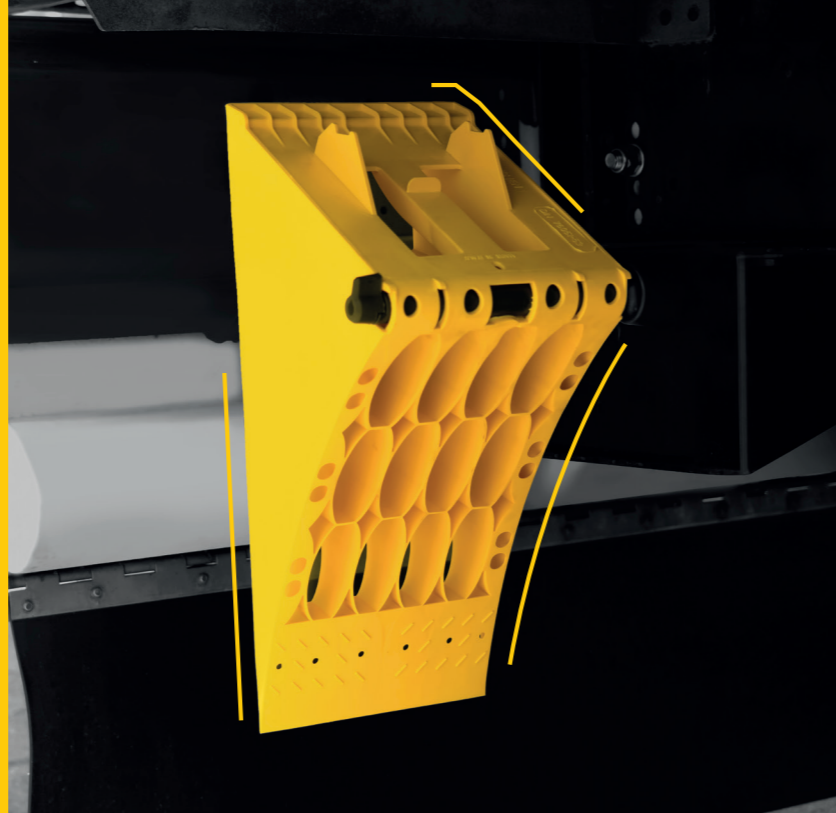

### HEAVY 53

PATENTED

HOMOLOGATION

DIN76051 - 53

COLOR CUSTOMIZATION

LOGO CUSTOMIZATION

LO GO

### CROWNY 53

PATENTED

HOMOLOGATION

DIN76051 - 53

### CROWNY 46

PATENTED

HOMOLOGATION

DIN76051 - 46

COLOR CUSTOMIZATION

LOGO CUSTOMIZATION

LO GO

### CROWNY 36

PATENTED

HOMOLOGATION

DIN76051 - 36

### KLOK



FOR G46/E53

PATENTED

COLOR CUSTOMIZATION

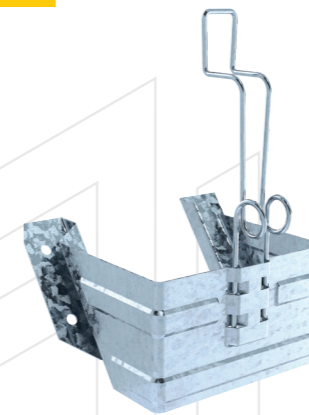

FOR E36/G46/E53

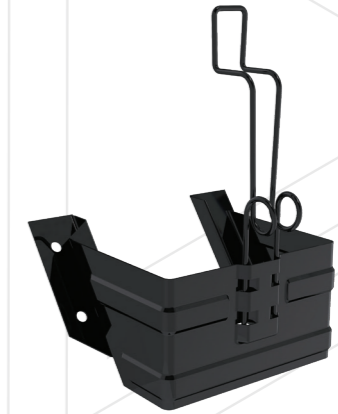

FOR G46/E53

### BEGIN

LOGO CUSTOMIZATION

LO GO

### NEST 90°-130°

COLOR CUSTOMIZATION



FOR E53

### HOST & DOUBLE

PATENTED

LOGO CUSTOMIZATION

COLOR CUSTOMIZATION

SCRATCH RESISTANT

LO GO



FOR G46/E53



FOR E36



www.lokhen.com



www.lokhen.com

# #Water on Board



## WATER TANKS



### SQUARE 18/30L



### GALLERY 30/50L

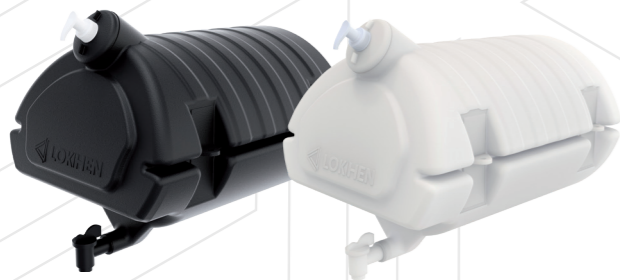

### START



### VERTICAL BRACKETS

DIMENSION CUSTOMIZATION

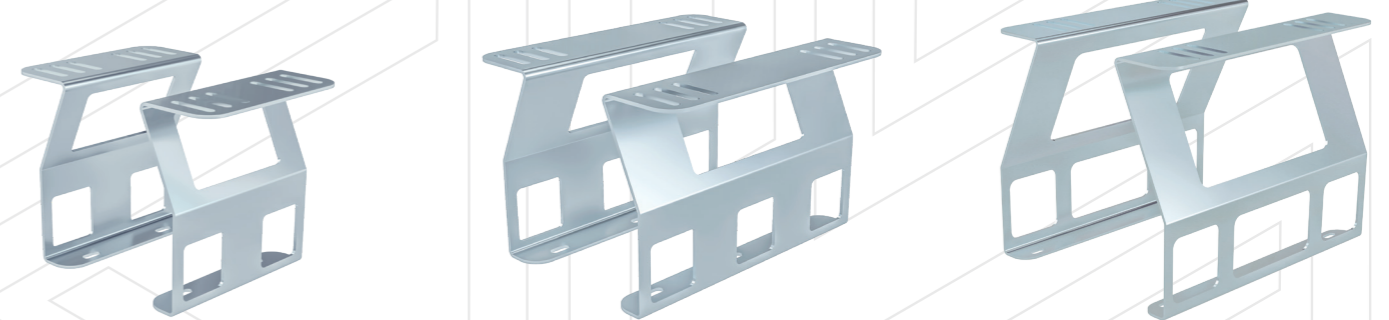

FOR SQUARE 18L

FOR SQUARE 30L

FOR GALLERY 30L

### HORIZONTAL BRACKETS

DIMENSION CUSTOMIZATION

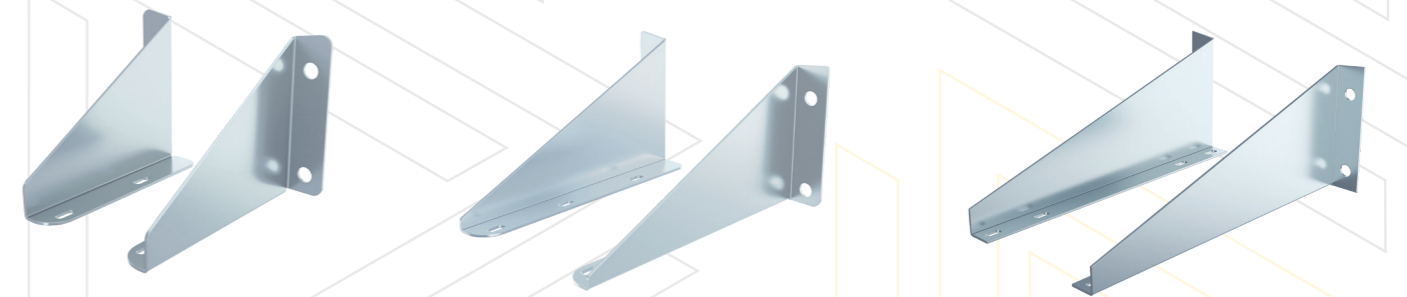

FOR SQUARE 18L

FOR SQUARE 18/30L

FOR GALLERY 30/50L



[www.lokhen.com](http://www.lokhen.com)



[www.lokhen.com](http://www.lokhen.com)

# #Quality on the Road



## HOSE TUBE HOLDERS

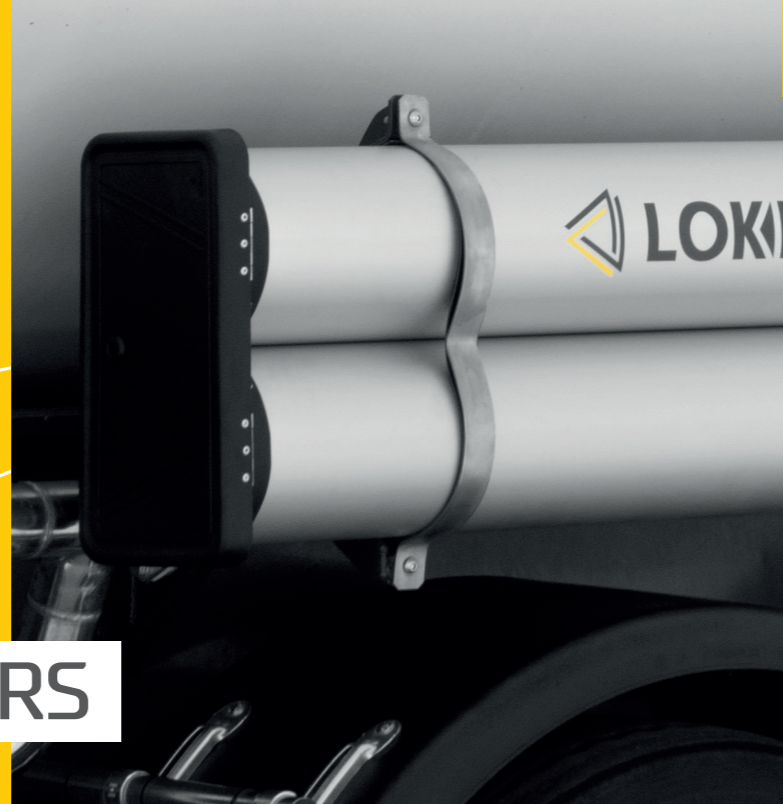

YOU CAN CHOOSE DIFFERENT FINISHES,  
DIAMETERS AND LENGTHS.

### PLASTIC KIT



### PLASTIC TUBE

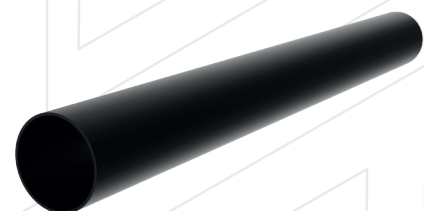

### ALUMINIUM KIT



### ALUMINIUM TUBE



5-6 METRES Ø 160/180/200

- PATENTED
- DIMENSION CUSTOMIZATION
- COLOR CUSTOMIZATION
- LOGO CUSTOMIZATION
- SCRATCH RESISTANT
- SECURITY SYSTEM

### SINGLE

VERSION Ø



160 mm  
200 mm

### DOUBLE

VERSION Ø



160 mm  
200 mm

### TRIPLE

VERSION Ø



160 mm  
200 mm

### SINGLE TANK

VERSION Ø



180 mm



www.lokhen.com



www.lokhen.com

# # Keep Safe



## DOCUMENTS HOLDERS

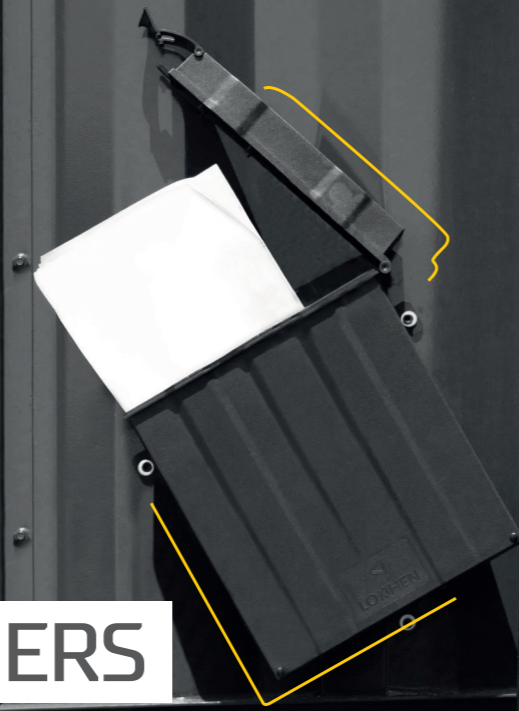

# # Highly Adaptable



## PVC PROFILES

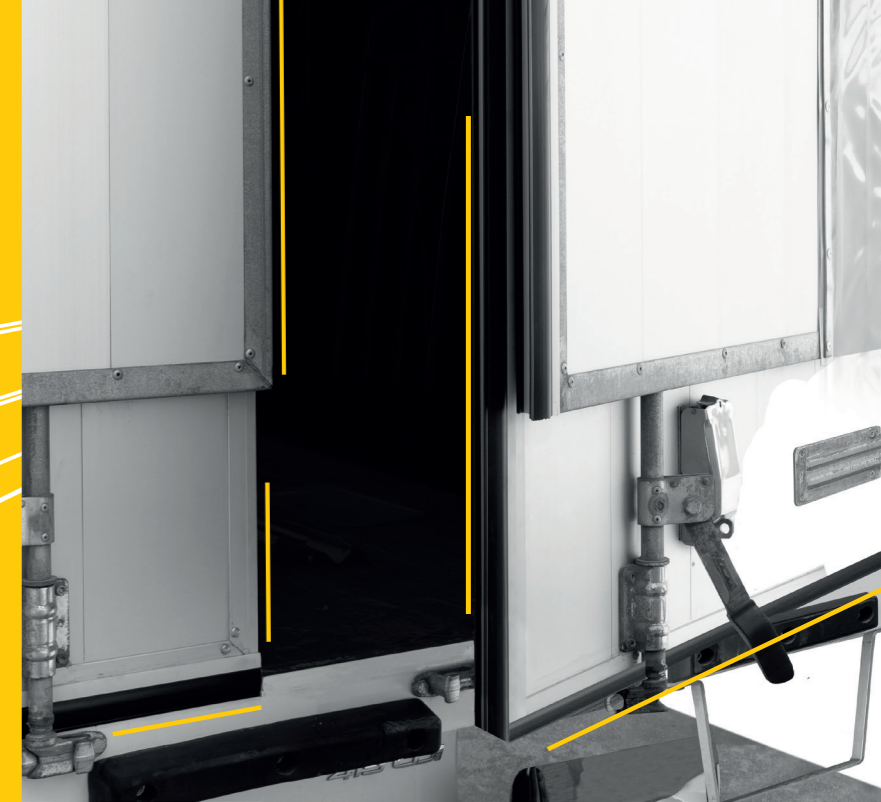

### BRIKY

NEW

PATENT PENDING



LOGO CUSTOMIZATION



COLOR CUSTOMIZATION



WATERPROOF



### ROLL

PATENTED



LOGO CUSTOMIZATION



COLOR CUSTOMIZATION



WATERPROOF



### RIGHT

PATENTED

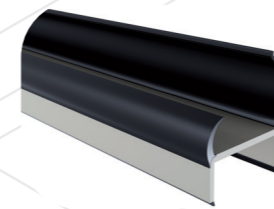

FOR DRY VEHICLES DOOR

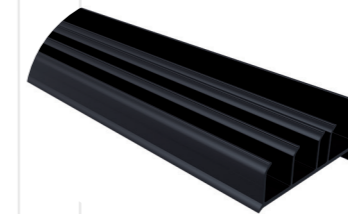

FOR REFRIGERATED VEHICLES DOOR

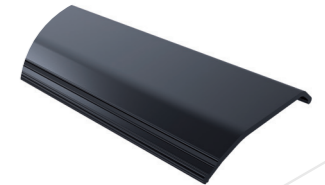

FOR SLIDING ROOF

NEW



FOR BACK AND LATERAL BUMPER



FOR TIPPER AND FLOAT

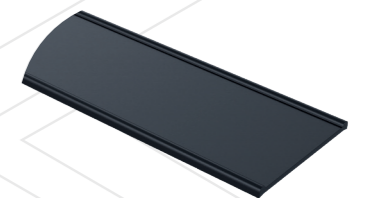

FOR RESERVOIRS AND TANKS

COLOR CUSTOMIZATION



DIMENSION CUSTOMIZATION



www.lokhen.com



www.lokhen.com



[lokhen.com](http://lokhen.com)

